

Музика

Тип Т 61-23

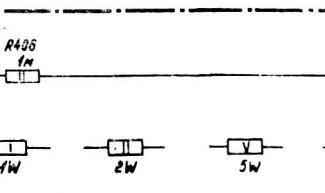

Забелешка: - Забодит запазва правото си да прави измененија в схемата
с цел подобрување квалитетот на приемирника.
- Пространците ширежега да се измерени с уред с R=50kΩ и др.

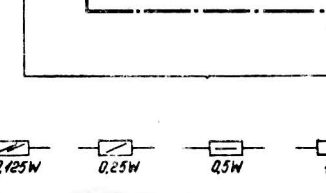
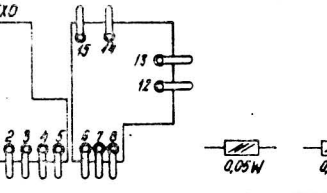
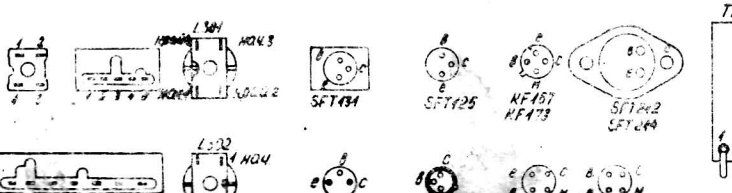
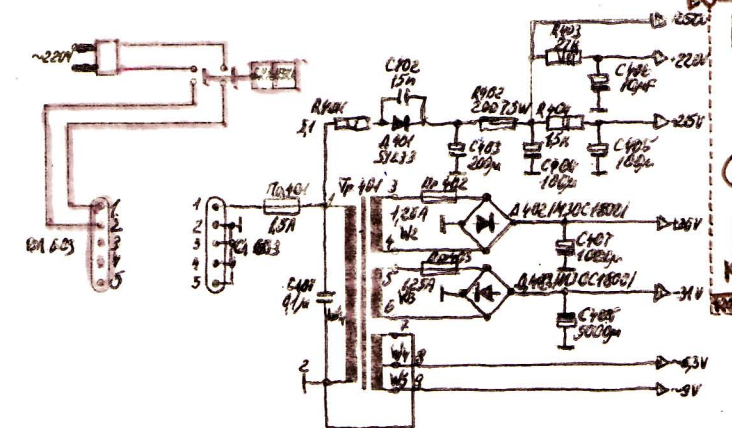
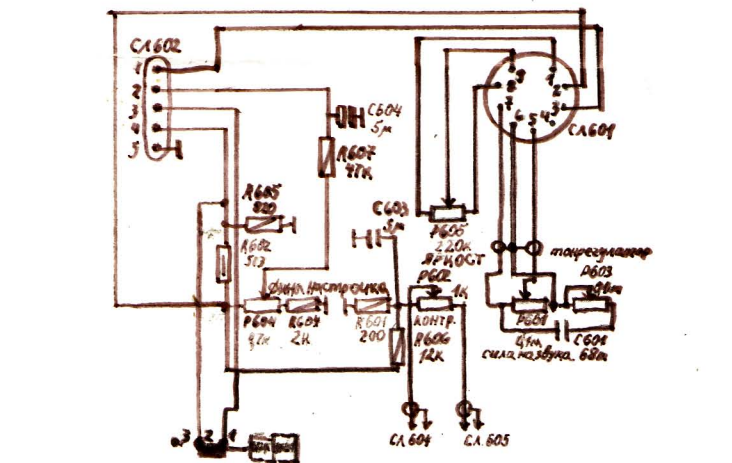
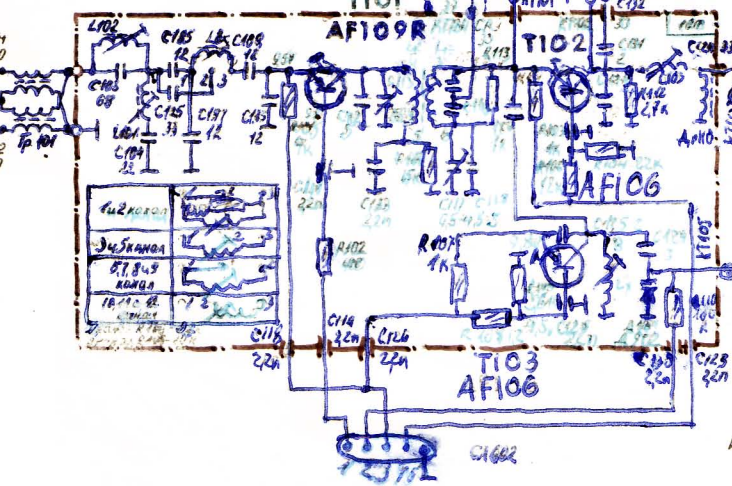
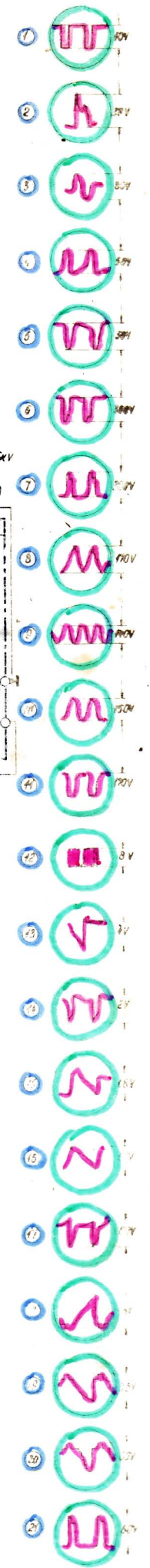
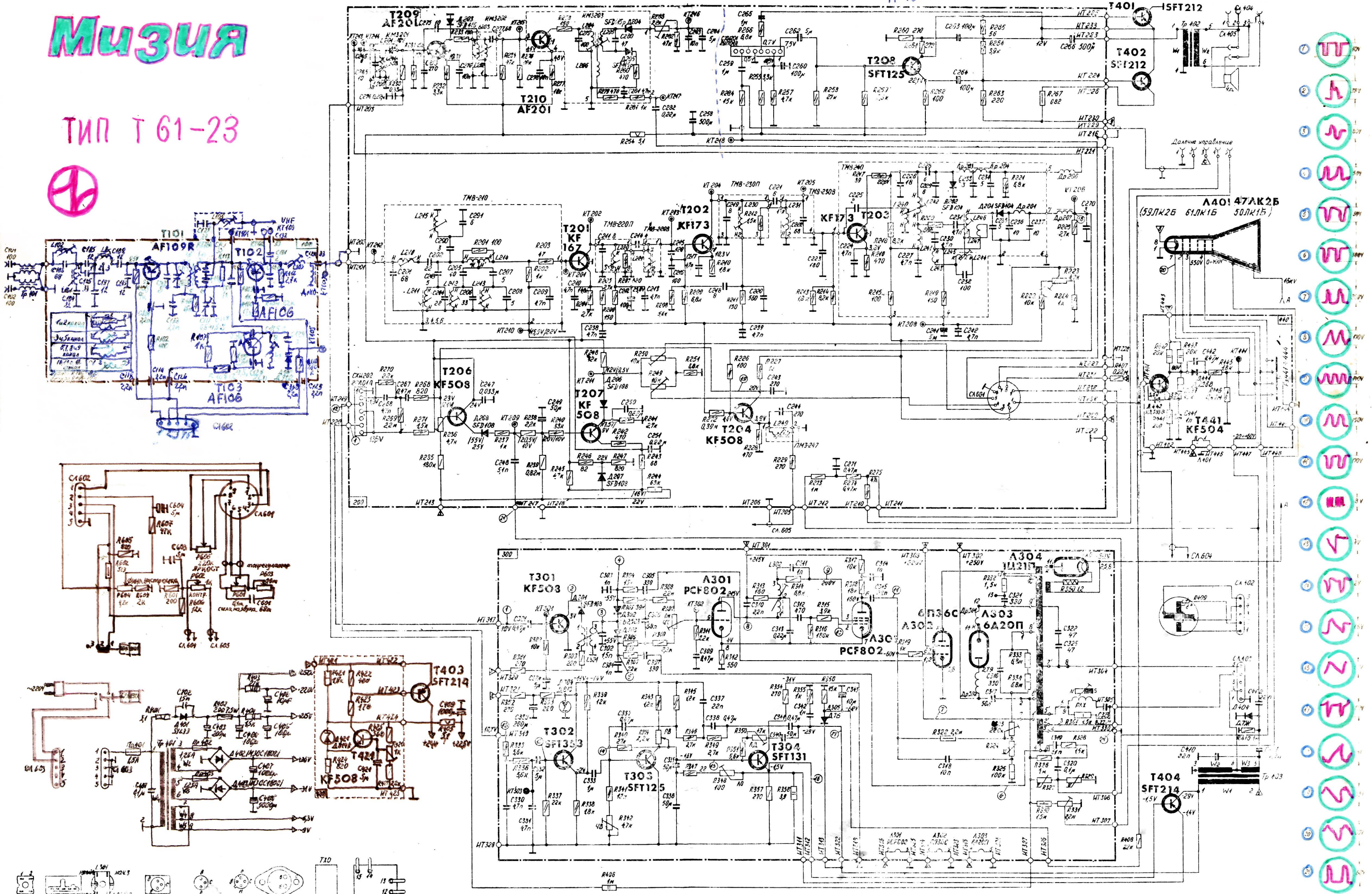
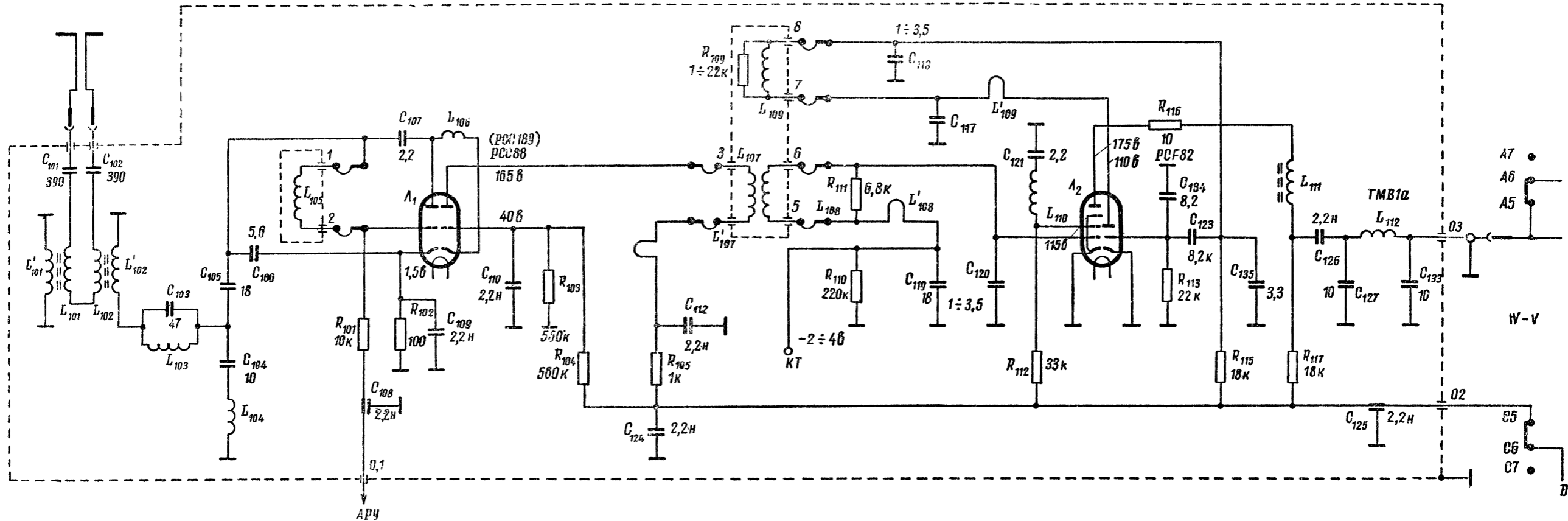

Фиг. 152. Най-често срещана схема на канален превключвател